

General Description

The MR16 LED Driver **Module** Evaluation board shows how to use the new AL8811 as a Boost LED driver for an inexpensive PFC front end and the new AL8807A as a Buck LED driver for a cost effective MR16 LED Driver circuit from which high PFC (~0.9) can be achieved.

Key Features

- Non-Dimmable or Triac Dimmable
- Front end Constant On time PFC circuit using the AL8811 Boost LED Driver
- New AL8807A Buck LED Driver
- PFC for the 12VAC input allowing multiple MR16 units on one transformer
- Compatible with Electronic Transformers

Applications

- MR16 LED Bulb
- Desktop lamps
- Under the counter lamps

AL8811EV2 Specifications

Parameter	Value
Input Voltage	12VAC
LED Current	660mA (Adjustable)
Number of LEDs	3 LEDs in series (Under Tested)
XY Dimension	0.8" x 0.88"

EVB (Rev 1.2)

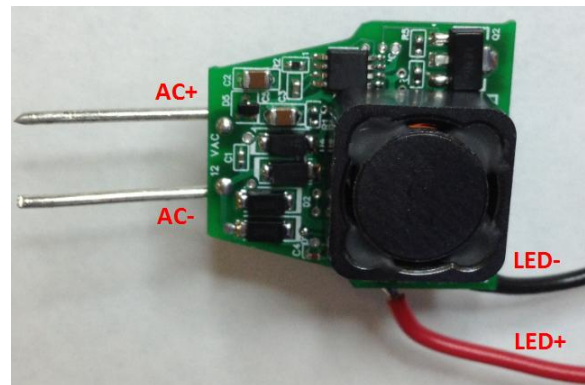

Figure 1: Top View

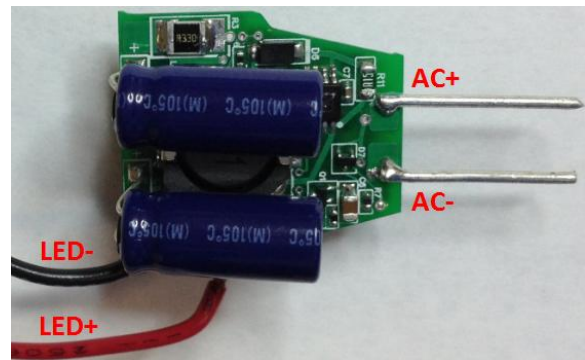

Figure 2: Bottom View

Connection Instructions

Input Voltage: 12VAC (AC+, AC-)

LED Outputs: LED+ (Red), LED- (Black)

Block Diagram:

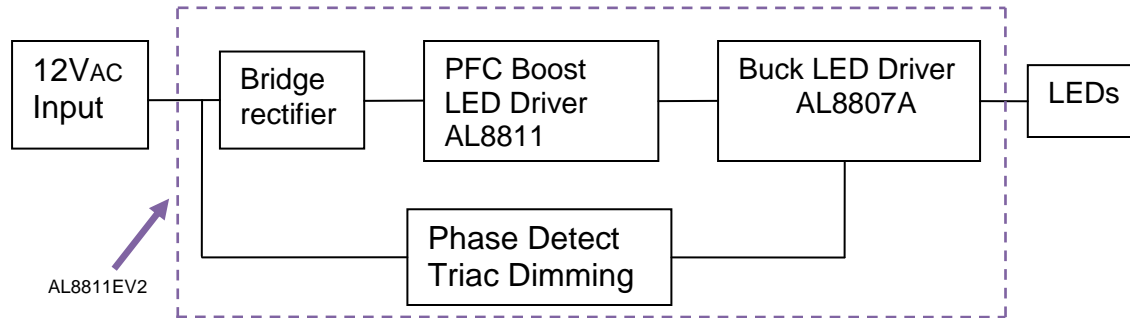

Figure 3: Block Diagram

Evaluation Board Schematic

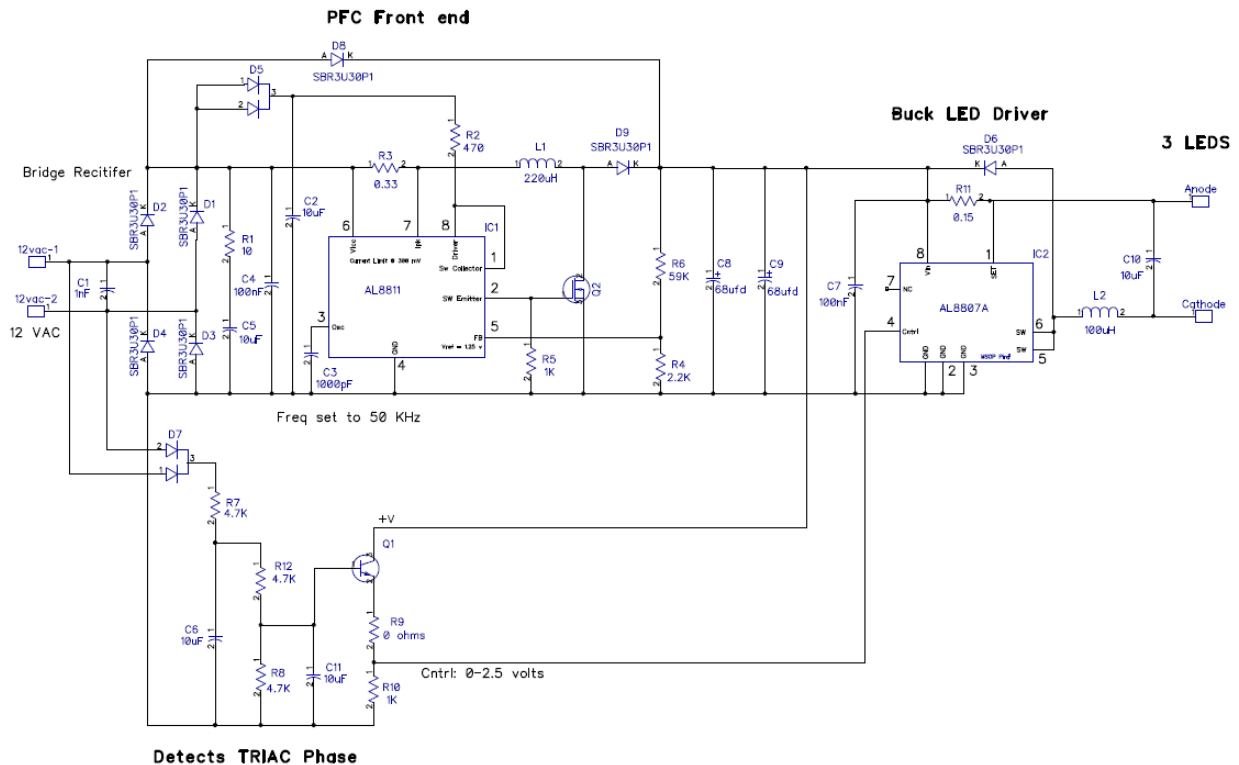

Figure 4: Evaluation Board Schematic

Evaluation Board Layout

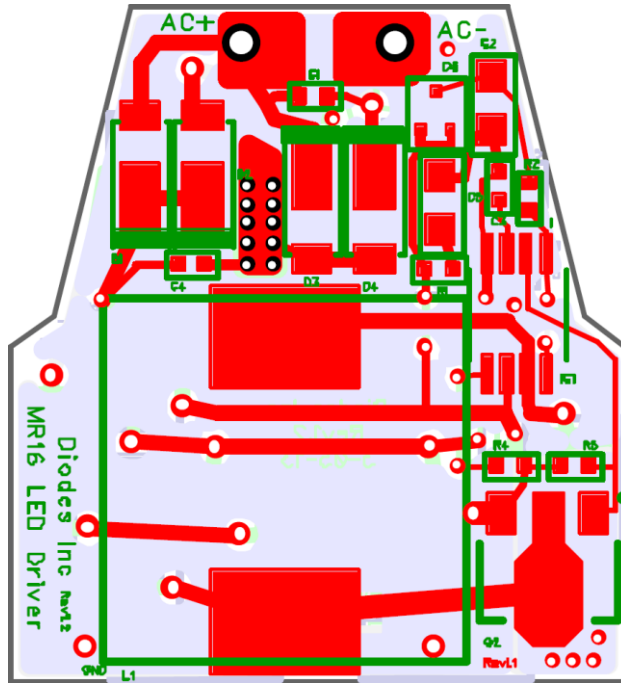

Figure 5: PCB Board Layout Top View

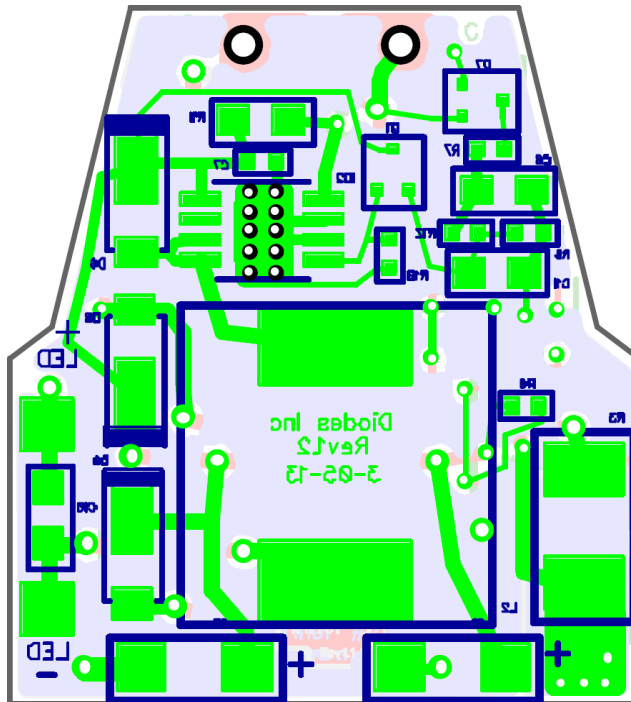

Figure 6: PCB Board Layout Bottom View

Quick Start Guide

1. By default, the evaluation board is preset at 660mA LED Current by R11.
2. Ensure that the AC source is switched OFF or disconnected.
3. Connect the 12V_{ac} AC line wires of power supply to two test points of “12VAC” on the left side of the board.
4. Connect the anode wire of external LED string to LED+ output test point.
5. Connect the cathode wire of external LED string to LED- output test point.
6. Turn on the main switch. LED string should light up.

Bill of Material

#	Name	Quantity	Part number	Manufacturer	Description
1	IC1	1	AL8811	Diodes Inc	Boost IC
2	IC2	1	AL8807A	Diodes Inc	Buck LED Driver
3	Q1	1	MMBT3904-7-F	Diodes Inc	NPN transistor
4	Q2	1	ZXMN6A11Z	Diodes Inc	N-MOSFET
5	D1-D4, D6,D8,D9	7	SBR3U30P1	Diodes Inc	Super Barrier Rectifiers
6	D5,D7	2	BAV70-7-F	Diodes Inc	BAV70 Dual diodes
7	L1	1	SRR1280-221K	Bourns	220μH, 1.6A Inductor for PFC stage
8	L2	1	ASPI-104S-101M-T	Abrakon	100μH, 1.35A Inductor for Buck Stage
9	R1	1	ERJ-2RKF10R0X	Panasonic	10Ω Resistor 1/10W 1% 0402 SMD
10	R2	1	ERJ—2RKF4700X	Panasonic	470Ω Resistor 1/10W 1% 0402 SMD
11	R3	1	MCR25JZHFLR330	Rohm Semiconductor	0.33Ω Resistor 1/2W 1% 1210 SMD
12	R4	1	ERJ-2RKF2201X	Panasonic	2.2kΩ Resistor 1/10W 1% 0402 SMD
13	R5, R10	2	ERJ-2RKF1001X	Panasonic	1kΩ Resistor 1/10W 1% 0402 SMD
14	R6	1	ERJ-2RKF5902X	Panasonic	59kΩ Resistor 1/10W 1% 0402 SMD
15	R7, R8, R12	3	ERJ-2RKF4701X	Panasonic	4.7kΩ Resistor 1/10W 1% 0402 SMD
16	R9	1	ERJ-3GEY0R00V	Panasonic	0Ω Resistor 1/10W 1% 0603 SMD
17	R11	1	RL1220S-R15-F	Susumu	0.15Ω Resistor 1/3W 1% 0805 SMD
18	C1, C3	2	C0402C102J5GACTU	Kemet	1000pF Cer Cap 50V 5% 0402 SMD
19	C2, C5, C6, C10, C11	5	C2012X5R1E106K125 AB	TDK	10μF Cer Cap 25V 10% X5R 0805
20	C4, C7	2	C1005X7R1H104K050 BB	TDK	0.1μF Cer Cap 50V 10% X7R 0402
21	C8, C9	2	ELXZ500ELL680MF15	United Chemi	68μF Aluminum Cap 50V 20% Radial

Functional Performance (Three series LEDs @660mA)

AL8811EV2 Module Board Performance (without dimmer and electronic transformer)										
Manuf	Board Type	VIN (VRMS)	IIN (IRMS)	PIN (W)	PF	VLED (V)	ILED (mA)	PLED (W)	ILED Ripple (%)	Efficiency (%)
Diodes Inc	AL8811EV2 Module Board	12	694.5	7.77	0.95	8.65	659.1	5.7	8	73.4

Functional Waveforms

For 120VAC dimmable MR16 design bench testing:

The electronic transformer type is Hatch RS12-150 / 150W.

The dimmer type is Lutron SELV-300P.

Following is a block diagram of the bench circuit that indicates voltage and current designations where the scope plots are functionally captured on the bench set-up. The bench set-up is used in the evaluation of the AL8811EV2 module dimmable MR16 design.

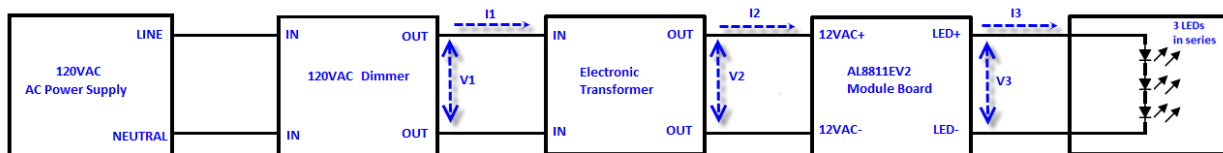
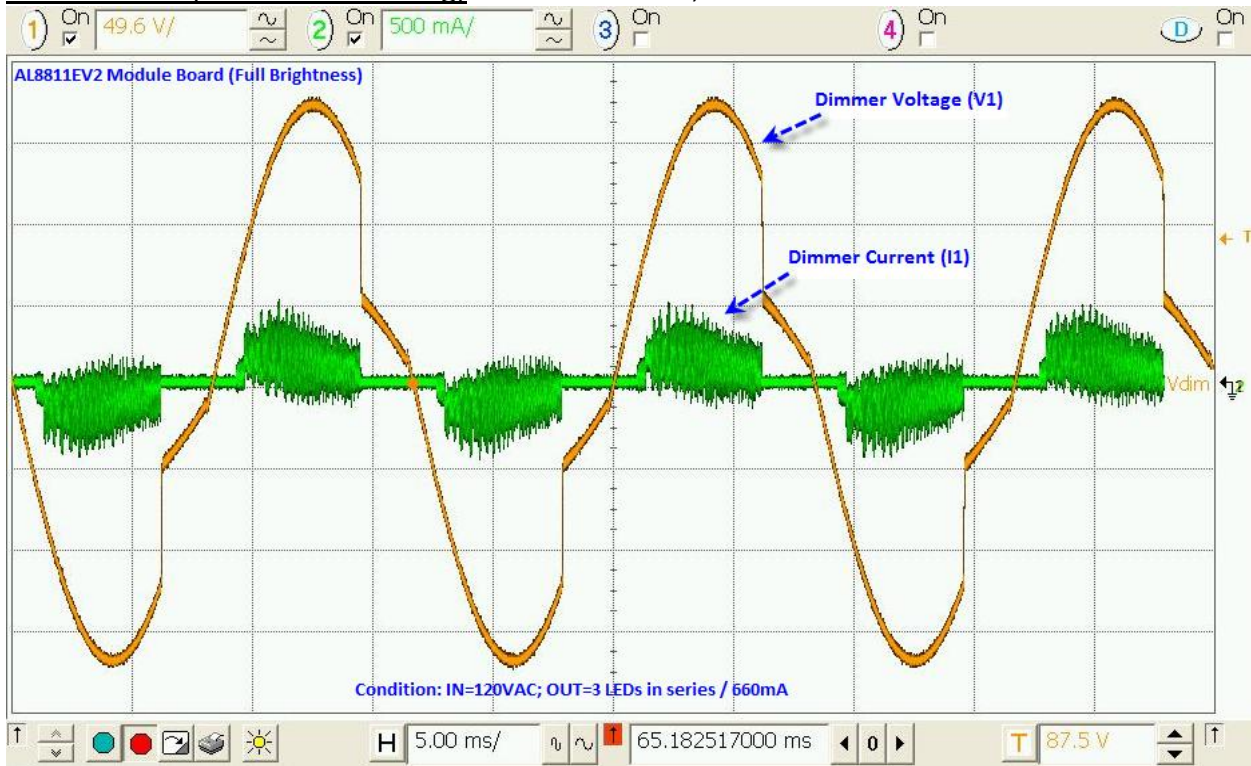
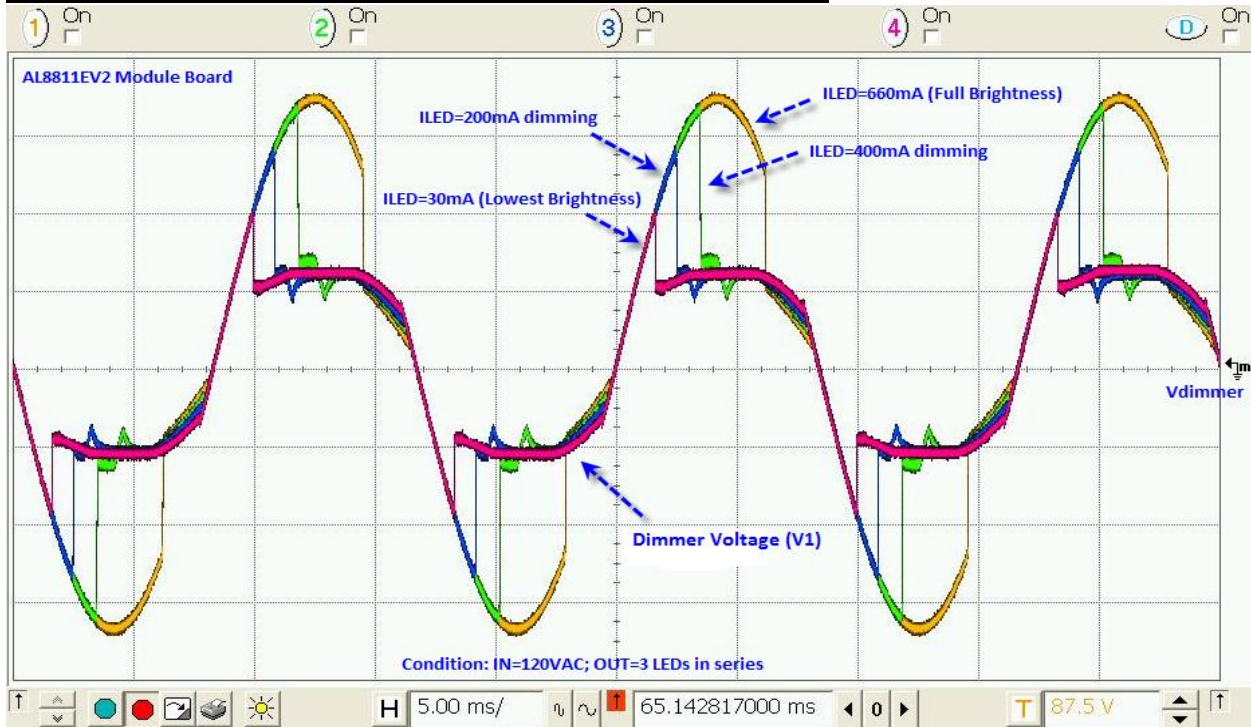

Figure 7: Bench Set-up Circuit

Waveform #1 (Maximum Dimming) => Channel 1: V1; Channel 2: I1



Waveform #2 (Dimming Control from full to lowest brightness) => Channel 1: V1



Waveform #3 (Maximum Dimming) => Channel 1: V2; Channel 2: I2

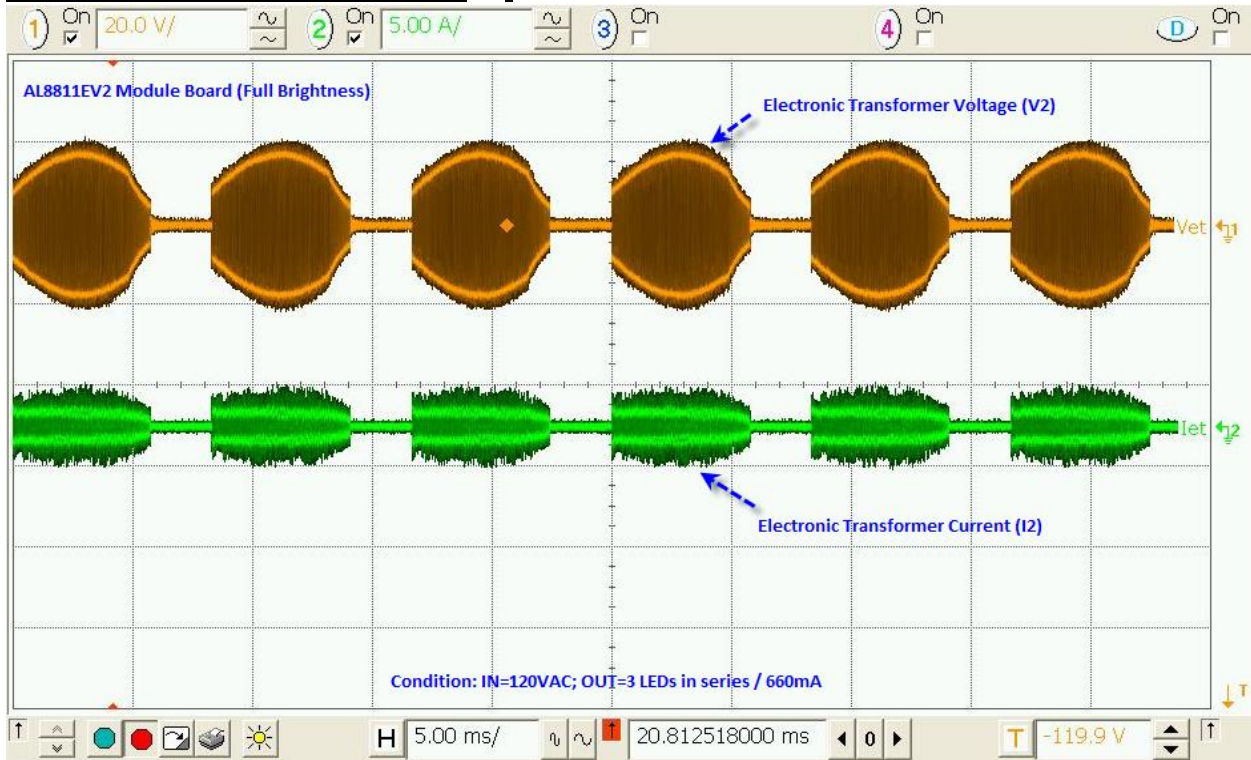

Waveform #4 (Zoom-in for Maximum Dimming) => Channel 1: V2; Channel 2: I2

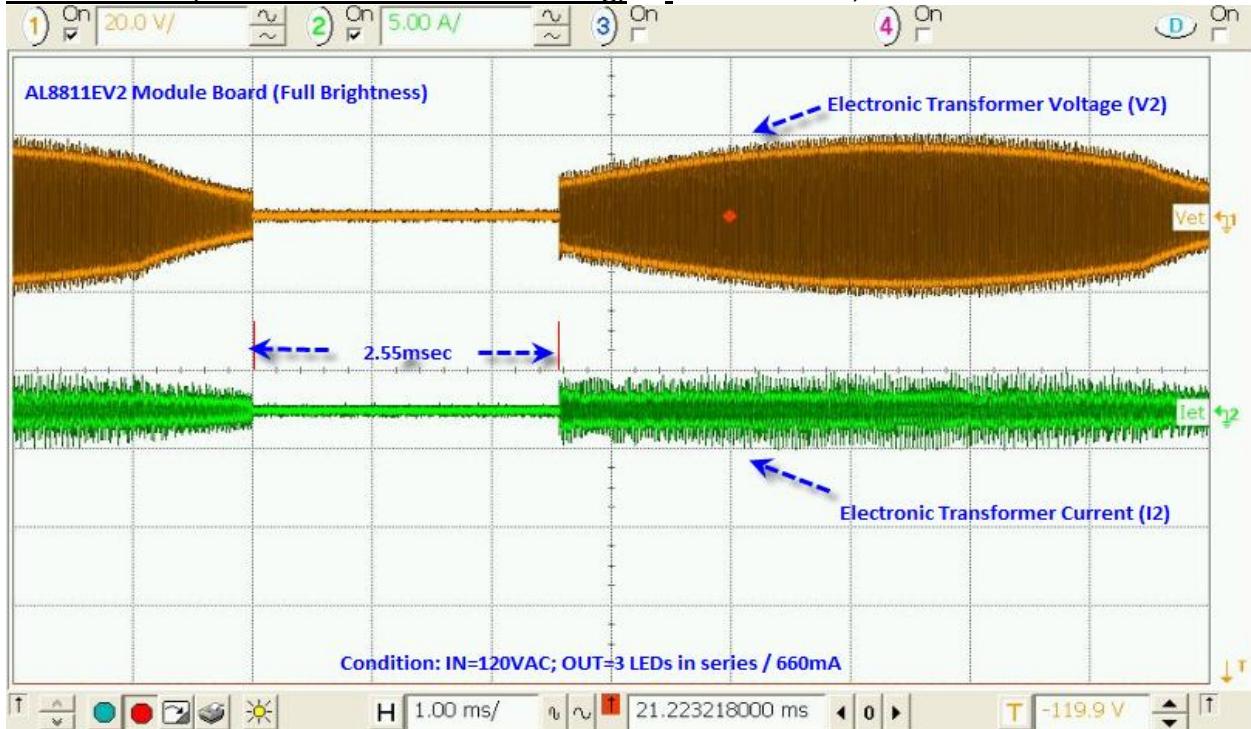

Waveform #5 (Maximum Dimming) => Channel 1: V2; Channel 2: I2

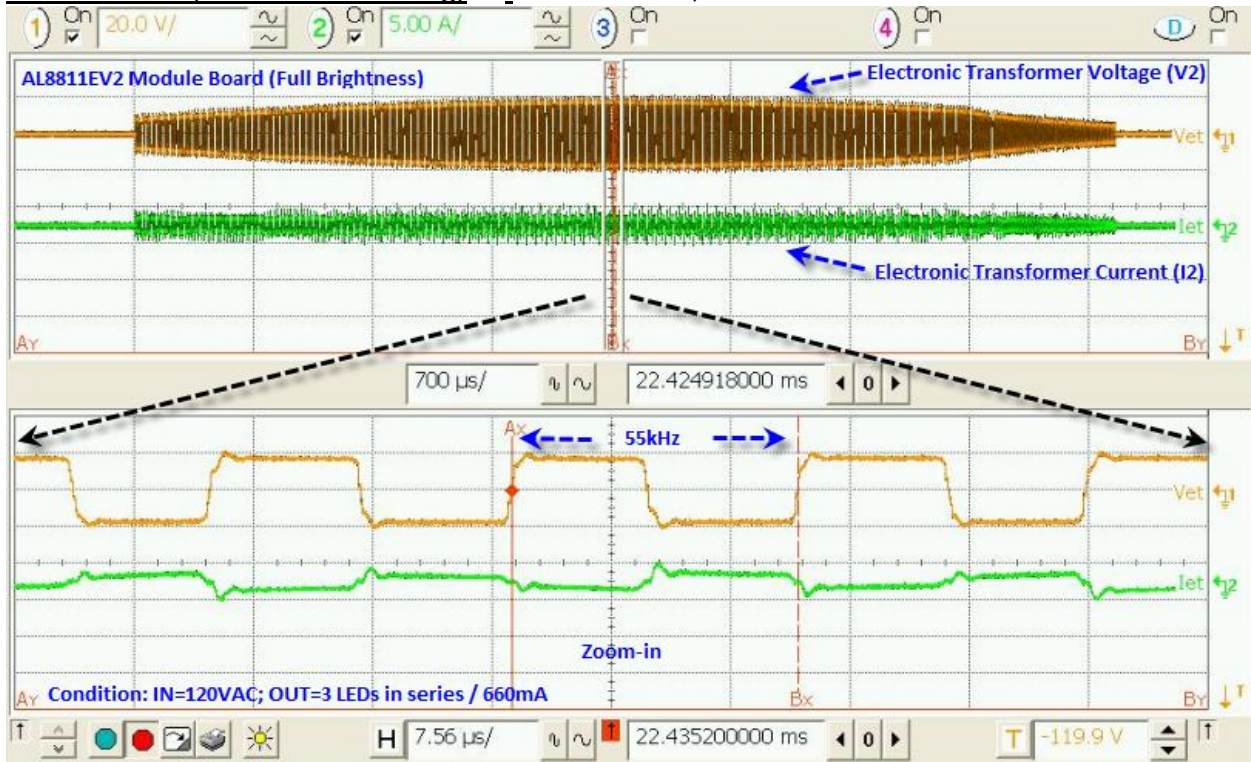

Waveform #6 (Dimming Control from full to lowest brightness) => Channel 1: V2

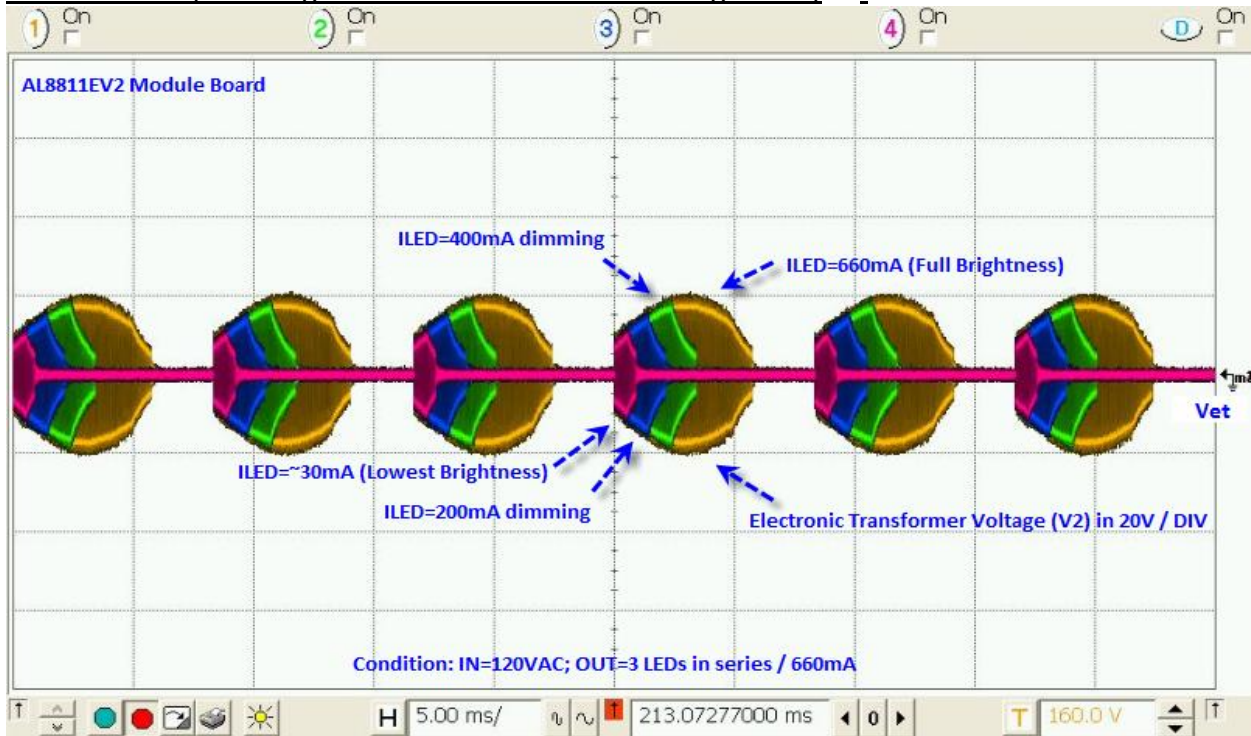

Waveform #7 (Dimming Control from full to lowest brightness) => Channel 2: I2

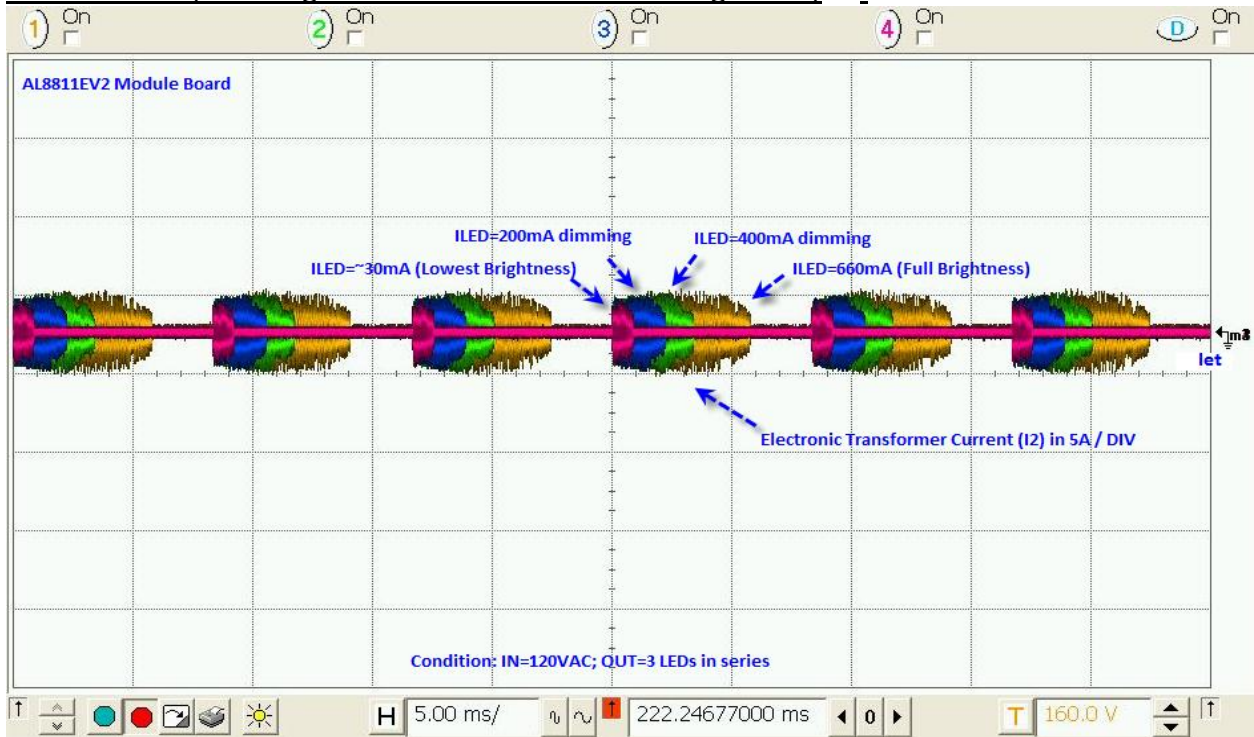

Waveform #8 (Maximum Dimming) => Channel 1: V2; Channel 2: I2; Channel 3: I3

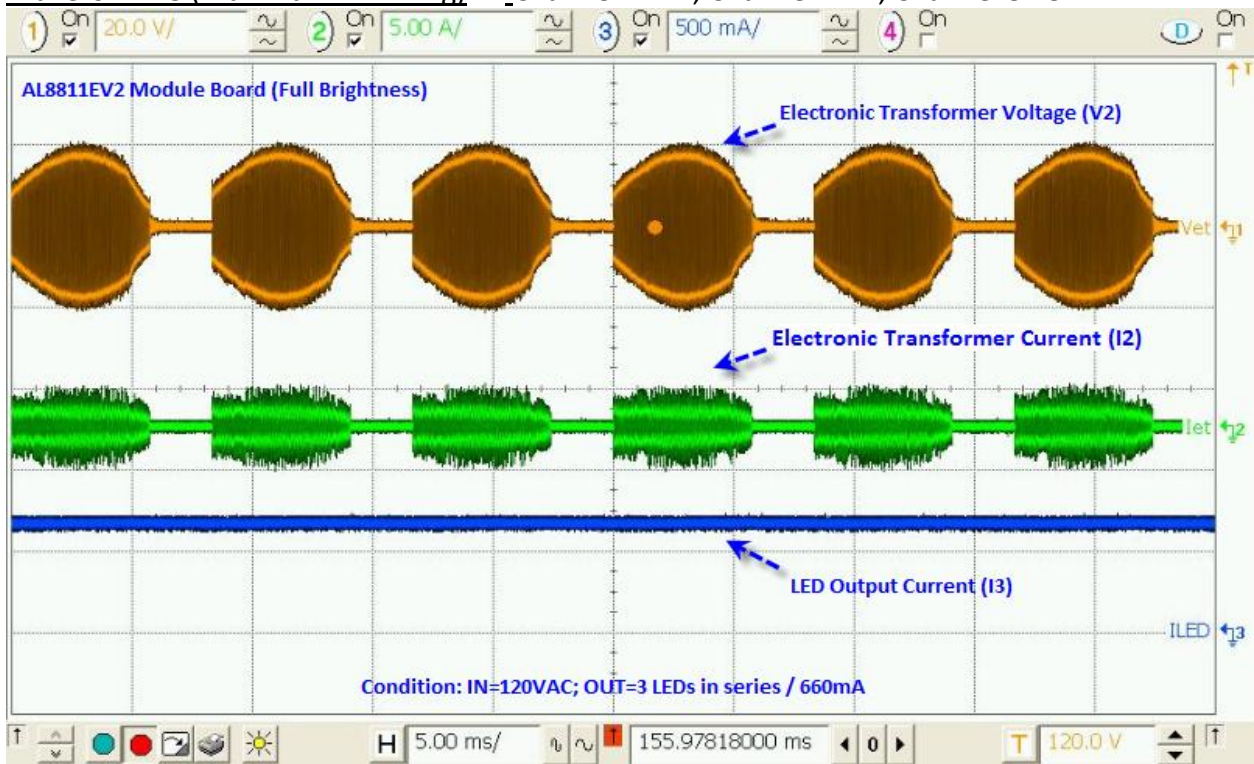

Waveform #9 (Maximum Dimming) => Channel 3: I3; Channel 4: V3

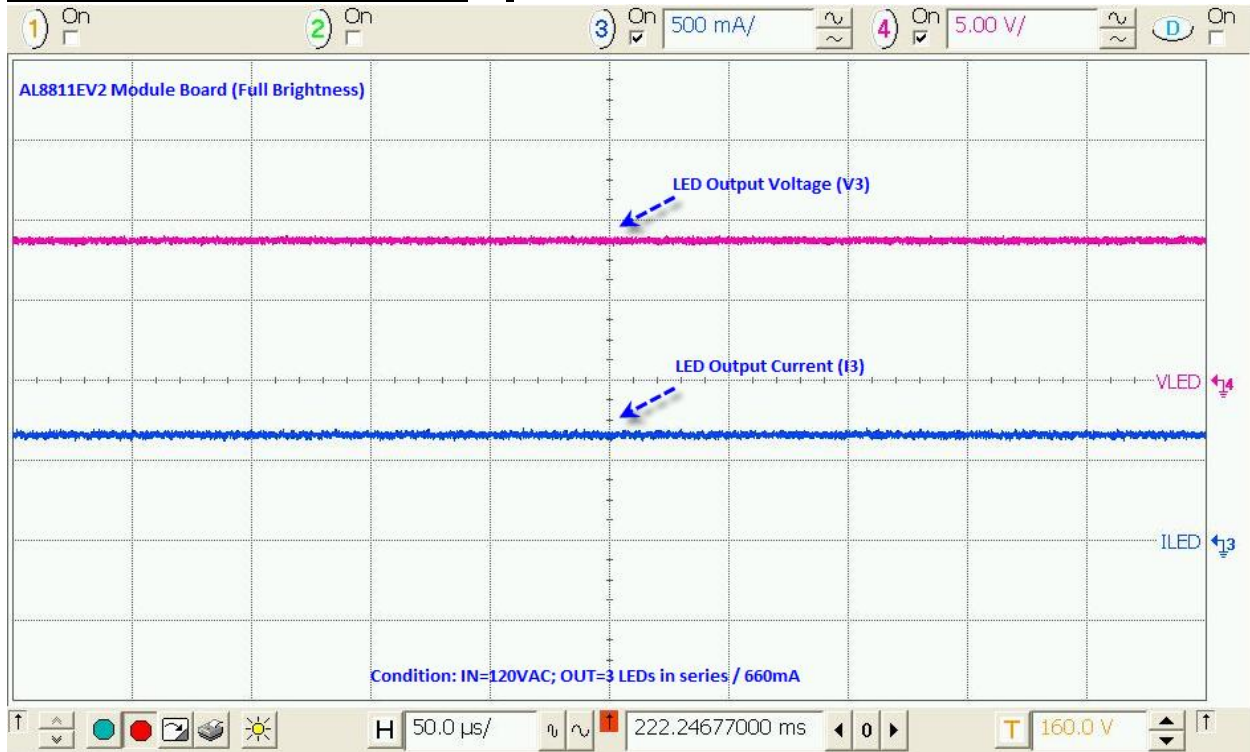

Waveform #10 (Dimming Control from full to lowest brightness) => Channel 3: I3

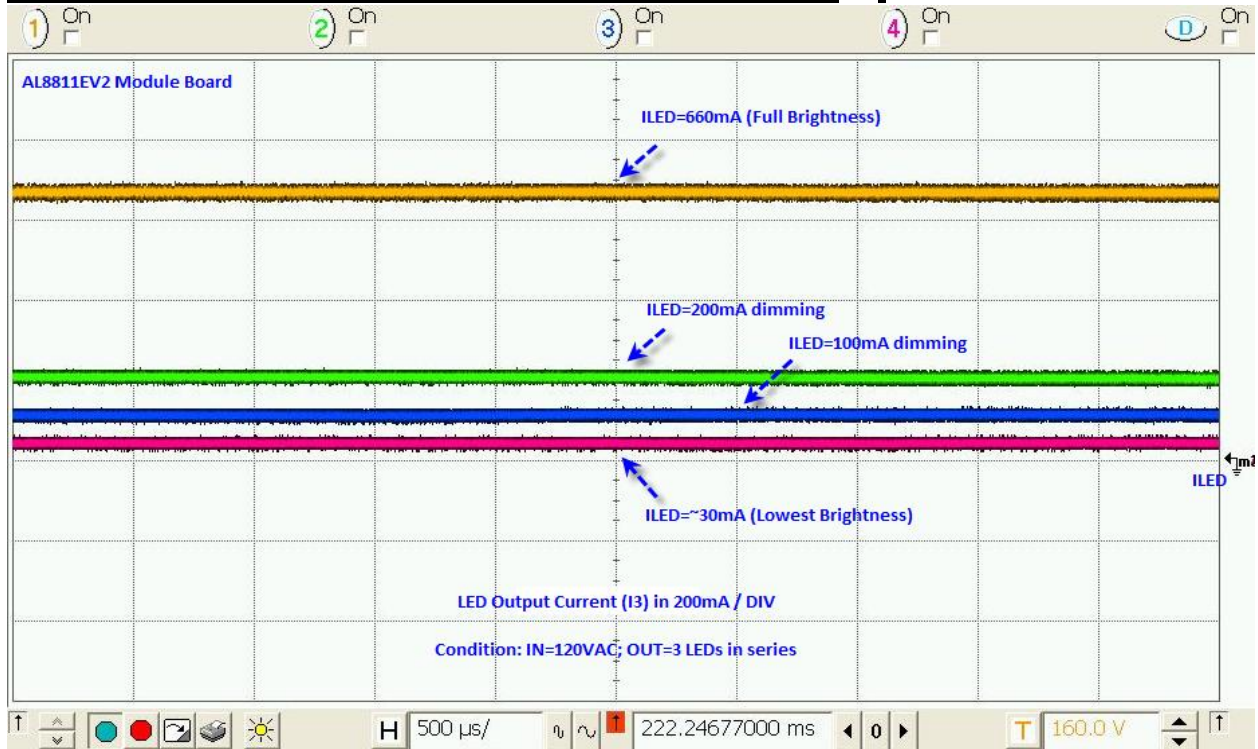

Functional Data Curves

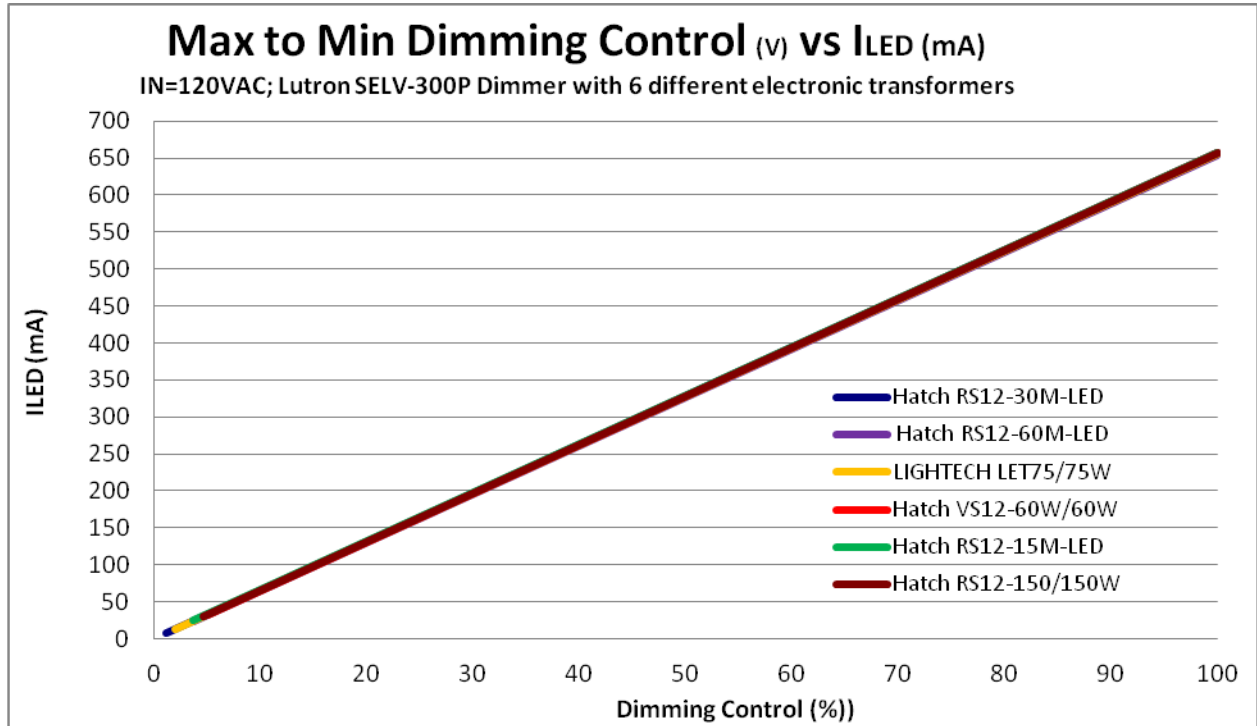

Transformer Compatibility List

1) 120VAC to 12VAC Electronic Transformers without dimmers in 3 LEDs in series:

Index	Electronic Transformers (120VAC to 12VAC)		Performance Result (No flicker)
	Brand	Model	
1	HATCH	RS12-30M-LED (30W)	✓
2	RSA	RT60A (60W)	✓
3	HATCH	RS12-150 (150W)	✓
4	HATCH	RS12-60M-LED (60W)	✓
5	HATCH	VS12-75W (75W)	✓
6	LIGHTECH	LET303 (300W)	✓
7	HATCH	RS12-60M (60W)	✓
8	HATCH	RS12-80M (80W)	✓
9	HATCH	VS12-60M (60W)	✓
10	HATCH	RS12-105 (105W)	✓
11	LIGHTECH	LET75 (75W)	✓
12	HATCH	VS12-60W (60W)	✓
13	HATCH	RS12-15M-LED (15W)	✓

2) 120VAC to 12VAC Electronic Transformers with dimmers in 3 LEDs in series

Index	Electronic Transformers (120VAC to 12VAC)		120VAC Dimmer Type	
	Brand	Model	LUTRON SELV-300P / 300W	LUTRON MAELV-600 / 600W
1	HATCH	RS12-30M-LED (30W)	✓	✓
2	HATCH	RS12-150 (150W)	✓	✓
3	HATCH	RS12-60M-LED (60W)	✓	✓
4	HATCH	RS12-150/150W	✓	✓
5	LIGHTECH	VS12-75W (75W)	✓	✓
6	HATCH	RS12-60M (60W)	✓	✓
7	HATCH	LET75 (75W)	✓	✓
8	HATCH	VS12-60W (60W)	✓	✓
9	HATCH	RS12-15M-LED (15W)	✓	✓

Note: ✓ = No Flicker

Application Information

Circuit Description

This design consists of three sections:

- 1) The input PFC circuit converts the 12V_{AC} input voltage to a DC voltage around 30V (AL8811).
- 2) The output Buck LED Driver drives the three LEDs in series at a fixed current (AL8807A).
- 3) Finally, the phase-detect circuit generates a voltage proportional to the phase of the incoming AC voltage (when triac dimming is used).

PFC Circuit

The AL8811 Boost converter is a simple “Constant ON time controller”. By keeping the same ON time throughout the AC cycle, the circuit will draw a current that will closely match the voltage and result in a constant input current. This eliminates the classic peak current problem with a bridge rectifier and a large input filter capacitor.

The PFC circuit includes the input bridge rectifier, EMI filter (if needed) and the AL8811 Boost converter. The AC input voltage is rectified by the bridge circuit and filtered by C1, R1, C4, and C5. This first filter removes the high frequency that is generated by the Electronic Transformer in the range of 20-30 KHz. An additional diode rectifier circuit (D5, C2) is used to generate a voltage that is used to power the circuit that will turn on/off the external MOSFET of the Boost converter. This circuit is very important as the gate drive of the MOSFET has to be greater than 3-4 volts throughout the AC cycle. The external MOSFET is used to reduce the heat dissipation in the AL8811.

The AL8811 has a current limit resistor R3 which sets the maximum current allowed through the inductor L1. The output voltage is set by the divider R6, R5 to an output of around 35 volts. The output voltage is filtered by the two capacitors C8 and C9. These two capacitors store energy that will be used when the input voltage is low during the AC cycle.

Buck LED Driver

The AL8807A is a step-down DC-DC converter designed to drive LEDs with a constant current. The current through the LED is controlled by R11. In the present Evaluation board, the current is set to around 660mA based on a resistor value of 0.15Ω. The current is set using the “CTRL” input pin which in this new version of the IC can vary from 0 to 2.5V, controlling the current from 0mA to the maximum current at 2.5V. This control input pin is used to lower the LED current as the TRIAC dims the LED. In this way, the energy stored in the two output capacitors

of the PFC circuit will be able to provide current throughout the AC cycle.

TRIAC Phase Detection Circuit

The phase of the TRIAC is detected by using an additional rectifier circuit that generates a voltage in proportional to the phase of the TRIAC Driver. This is done by rectifying the input AC voltage and averaging the energy using a resistor to charge a capacitor. Two additional resistors in series, R12 and R8, slowly discharge this circuit so it will follow the input phase change. The two resistors, R12 and R8, are used to scale the voltage so the range is from 0 to 2.6V to the Buck LED driver control pin.

A simple transistor emitter follower circuit is used to drive a 1K resistor in the emitter circuit. This low resistance is needed to drive the input control pin of the AL8807A LED driver because the pin outputs a small current of 50uA, which limits the lowest control voltage to around 50 mV.

Setting the LED output current (AL8807A):

The LED output current is set using resistor R11 and the formula:

$$I_{LED} = V_{TH} / R11 \quad \text{where } V_{TH} \text{ is equal to } 0.1V$$

For a current of 660mA, R11 is about 0.15Ω.

Setting the PFC Variables (AL8811)

The choice for the size of the boost converter inductor selected in this design is based on a compromise which it is able to support a peak current to around 1.5A since the average input voltage will be around 12-14V.

The boost converter (AL8811) includes a current limit resistor R3 which will limit the current through the inductor and thus the power delivered to the output load. The formula for the resistor is:

$$I_{PK(\text{switch})} = 0.33V / R3$$

For a current limit of 1A, R3 is 0.33Ω.

In this evaluation design, this value was selected based on having three LEDs in series drawing about 660mA. It was found that two 68μF capacitors mounted in parallel would just fit into the cavity of the MR16 bulb. The important design goal is to have the PFC circuit, which is used to always draw current from the Electronic Transformer.

Performance Description

The evaluation board allows the testing of different combinations of circuit component values to match the final design specifications. The main design goal is to have a constant load on the Electronic Transformer so that it will be operating throughout the AC cycle. This is accomplished when the input power is about the same as the output power.

Overall, there are three major components that are essential to the operation of the circuit.

The first component to select is the resistor (R11) in the Buck LED driver (AL8807A) that sets the final current through the LED string. This will set the amount of power the system needs.

The second component is the size of the R3 which limits the current provided to the output filter capacitors. This should be adjusted so that the boost input circuit by AL8811 LED driver is always running and thus providing a load to the Electronic Transformer. This usually means that the output voltage of the PFC circuit will have a large ripple. This will be okay as long as the lowest voltage is higher than the maximum final LED string voltage.

The third component is the output capacitors (C8 and C9) of the PFC circuit. These should not be too large that the PFC circuit stops working. If it happens, the resonant circuit of the Electronic Transformer will become erratic and cause the LEDs to flicker.

IMPORTANT NOTICE

DIODES INCORPORATED MAKES NO WARRANTY OF ANY KIND, EXPRESS OR IMPLIED, WITH REGARDS TO THIS DOCUMENT, INCLUDING, BUT NOT LIMITED TO, THE IMPLIED WARRANTIES OF MERCHANTABILITY AND FITNESS FOR A PARTICULAR PURPOSE (AND THEIR EQUIVALENTS UNDER THE LAWS OF ANY JURISDICTION).

Diodes Incorporated and its subsidiaries reserve the right to make modifications, enhancements, improvements, corrections or other changes without further notice to this document and any product described herein. Diodes Incorporated does not assume any liability arising out of the application or use of this document or any product described herein; neither does Diodes Incorporated convey any license under its patent or trademark rights, nor the rights of others. Any Customer or user of this document or products described herein in such applications shall assume all risks of such use and will agree to hold Diodes Incorporated and all the companies whose products are represented on Diodes Incorporated website, harmless against all damages.

Diodes Incorporated does not warrant or accept any liability whatsoever in respect of any products purchased through unauthorized sales channel.

Should Customers purchase or use Diodes Incorporated products for any unintended or unauthorized application, Customers shall indemnify and hold Diodes Incorporated and its representatives harmless against all claims, damages, expenses, and attorney fees arising out of, directly or indirectly, any claim of personal injury or death associated with such unintended or unauthorized application.

Products described herein may be covered by one or more United States, international or foreign patents pending. Product names and markings noted herein may also be covered by one or more United States, international or foreign trademarks.

LIFE SUPPORT

Diodes Incorporated products are specifically not authorized for use as critical components in life support devices or systems without the express written approval of the Chief Executive Officer of Diodes Incorporated. As used herein:

- A. Life support devices or systems are devices or systems which:
 - 1. are intended to implant into the body, or
 - 2. support or sustain life and whose failure to perform when properly used in accordance with instructions for use provided in the labeling can be reasonably expected to result in significant injury to the user.
- B. A critical component is any component in a life support device or system whose failure to perform can be reasonably expected to cause the failure of the life support device or to affect its safety or effectiveness.

Customers represent that they have all necessary expertise in the safety and regulatory ramifications of their life support devices or systems, and acknowledge and agree that they are solely responsible for all legal, regulatory and safety-related requirements concerning their products and any use of Diodes Incorporated products in such safety-critical, life support devices or systems, notwithstanding any devices- or systems-related information or support that may be provided by Diodes Incorporated. Further, Customers must fully indemnify Diodes Incorporated and its representatives against any damages arising out of the use of Diodes Incorporated products in such safety-critical, life support devices or systems.

Copyright © 2013, Diodes Incorporated

www.diodes.com